

MITSUBISHI

GT15 CF card extension unit

User's Manual

GT15-CFEX-C08SET
Set of GT15-CFEX, GT15-CFEXIF, and GT15-C08CF

Thank you for purchasing the GOT1000 Series.

Prior to use, please read both this manual and detailed manual thoroughly to fully understand the product.

MODEL	GT15-CFEX-C08SET-U
MODEL CODE	1D7M64
	IB(NA)-0800367-F(1106)MEE

GRAPHIC OPERATION TERMINAL
GOT1000

SAFETY PRECAUTIONS

(Be sure to read these instructions before use.)

Before using this product, read this and relevant manuals carefully and handle the product correctly with full attention to safety. Note that these precautions apply only to this product. In this manual, SAFETY PRECAUTIONS are classified into 2 levels: "DANGER" and "CAUTION".

DANGER Indicates that incorrect handling may cause hazardous conditions, resulting in death or severe injury.

CAUTION Indicates that incorrect handling may cause hazardous conditions, resulting in medium or slight personal injury or physical damage.

Under some circumstances, failure to observe the CAUTION level instructions may also lead to serious accidents. Be sure to observe the instructions of both levels to ensure the safety. Please keep this manual in a safe place for future reference and also pass this manual on to the end user.

Design precautions

CAUTION

- Do not bunch the control wires or communication cables with the main circuit or power wires, or lay them close to each other. As a guide, separate the lines by a distance of at least 100mm (3.94 inches) otherwise malfunctions may occur due to noise.

Installation precautions

DANGER

- Be sure to shut off all phases of the external power supply used by the system before mounting or removing this unit to/from the GOT. Not doing so can cause the unit to fail or malfunction.

DANGER

- When installing this unit, wear a wrist strap to prevent the unit from being damaged by static electricity.
- Be sure to shut off all phases of the external power supply of the GOT main unit before connecting the cable to this unit. Not doing so can cause the unit to fail or malfunction.

CAUTION

- Use this unit in the environment that satisfies the general specifications described in the User's Manual for the GOT used. Not doing so can cause an electric shock, fire, malfunction or product damage or deterioration.
- When installing the GOT side installation unit, fit it to the connection interface of the GOT and tighten the mounting screws. When installing the control panel side installation unit, install it on the control panel and tighten the screws of the installation fittings. If the screw is too loose, it may cause a drop of the unit, a failure or malfunctions. Tightening the screw excessively may damage the screw and/or the unit, resulting in a drop of the unit, a failure or malfunctions.
- When installing a CF card into this unit, be sure to insert it into the card slot of this unit.
- Before inserting or removing a CF card into/from this unit, turn the CF card access switch off. Failure to do so may corrupt data on the CF card.
- When removing a CF card from the GOT, support it by hand, as it may pop out. Failure to do so may cause the CF card to drop from the unit, resulting in a damage or failure.

Wiring precautions

DANGER

- Be sure to shut off all phases of the external power supply used by the system before wiring. Failure to do so may result in an electric shock, product damage or malfunctions.

CAUTION

- Carefully prevent foreign matter such as dust or wire chips from entering this unit. Failure to do so may cause a fire, failure or malfunctions.
- Plug the cable into the connector of the connected unit and tighten the mounting screws. If the screw is too loose, it may cause a short circuit or malfunctions. If too tight, it may damage the screw and/or the unit, resulting in a short circuit or malfunctions.

Startup and maintenance precautions

DANGER

- Be sure to shut off all phases of the external power supply of the GOT main unit before starting cleaning. Not doing so can cause the unit to fail or malfunction.

CAUTION

- Do not disassemble or modify this unit and CF card. Doing so can cause failure, malfunctions, personal injuries and/or a fire.
- Do not touch the conductive and electronic parts of this unit directly. Doing so can cause a unit malfunction or failure.
- The cable connected to this unit must be run in a duct or clamped. Not doing so can cause the unit or cable to be damaged due to the dangling, motion or accidental pulling of the cable or can cause a malfunction due to a cable connection fault.
- When unplugging the cable connected to this unit, do not hold and pull the cable portion. Doing so can cause the unit or cable to be damaged or can cause a malfunction due to a cable connection fault.

CAUTION

- Do not drop or apply strong impact to this unit or the CF card. Doing so may damage the unit or CF card.
- Before handling this unit, touch a grounded metal object to discharge the static electricity from the human body. Failure to do so may cause failure or malfunctions of the unit.

Disposal precautions

CAUTION

- When disposing of the product, treat it as an industrial waste.

Transportation precautions

CAUTION

- Make sure to transport this unit in the manner it will not be exposed to the impact exceeding the impact resistance described in the general specifications of the User's Manual for the GOT used, as it is a precision device. Failure to do so may cause the unit to fail. Check if the unit operates correctly after transportation.

MANUALS

The following shows manuals relevant to this product.

Manual name	Manual number (Model code)
GT16 User's Manual (Hardware) (Sold separately)	SH-080928ENG (1D7MD3)
GT15 User's Manual (Sold separately)	SH-080528 (1D7M23)

Relevant Manuals

For relevant manuals, refer to the PDF manuals stored in the CD-ROM for the drawing software used.

© 2006 MITSUBISHI ELECTRIC CORPORATION

Compliance with the EMC and Low Voltage Directives

To configure a system meeting the requirements of the EMC and Low Voltage Directives when incorporating the Mitsubishi GOT (EMC and Low Voltage Directives compliant) into other machinery or equipment, refer to "EMC AND LOW VOLTAGE DIRECTIVES" of the General Description included with the GOT used. The CE mark, indicating compliance with the EMC and Low Voltage Directives, is printed on the rating plate of the GOT.

Compliance with the Radio Waves Act (South Korea)

This product complies with the Radio Waves Act (South Korea). Note the following when using the product in South Korea.

이 기기는 업무용 (A급) 전자파차폐기기로서 판매자 또는 사용자는 이 점을 주의하시기 바라며, 가정외의 지역에서 사용하는 것을 목적으로 합니다. (The product is for business use (Class A) and meets the electromagnetic compatibility requirements. The seller and the user must note the above point, and use the product in a place except for home.)

Packing List

The following items are included.

Model	Product	Quantity
GT15-CFEX-C08SET	Control panel side installation unit	1
	Installation fitting	2
	CF card cover fixing screw	1
GT15-CFEXIF	GOT side installation unit	1
	Fixing screw for GOT side installation unit	2
GT15-C08CF	Shorting bar	1
	Connection cable (0.8m)	1

1. OVERVIEW

This User's Manual describes the GT15 CF card extension unit (hereinafter referred to as the CF card extension unit). For GOT to which the units can be installed and usable CF cards, refer to the User's Manual for the GOT used.

When using an additional drive, the CF card extension unit can be used as the B drive of the GOT. The extension units used as the B drive of the GOT are a CF card unit and a CF card extension unit. The CF card unit and the CF card extension unit cannot be used at once.

When using the CF card extension unit, the control panel side installation unit on the control panel has the CF card interface. Therefore, when inserting or ejecting the CF card, there is no need to open the control panel's door.

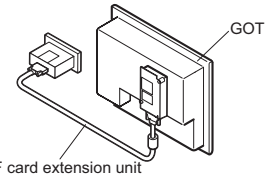

When using the CF card extension unit, set the Communication Settings. For setting, refer to the User's Manual for the GOT used.

2. SPECIFICATIONS

The following table shows the performance specifications of the CF card extension unit.

The general specifications of the CF card extension unit are the same as those of the GOT.

For the general specifications of the GOT, refer to the User's Manual for the GOT used.

Item	Specifications	
Internal current consumption (5VDC)	0.15A (Total current of GT15-CFEX and GT15-CFEXIF)	
Protective structure	Outside the enclosure CF card cover closed	IP67 or IP65 *
	Inside the enclosure CF card cover opened	IP2X
Weight	0.47kg (1.03lb)	

* When changing the dustproof rubber to the CF card cover fixing screw, the specification for the protective structure is IP67.

3. PART NAMES AND EXTERNAL DIMENSIONS

(1) GOT side installation unit

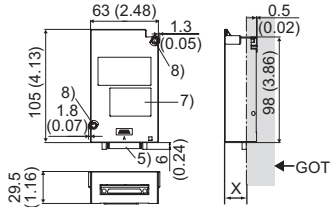

Dimensions of X when installing the unit on the GOT

GOT	GT16	GT15
15"	18.5 (0.73)	20 (0.79)
12.1"	17 (0.67)	17 (0.67)
10.4"	20 (0.67)	20 (0.67)
8.4"	22 (0.87)	22 (0.87)
5.7"	22 (0.87)	22 (0.87)

Unit: mm(inch)

(2) Control panel side installation unit

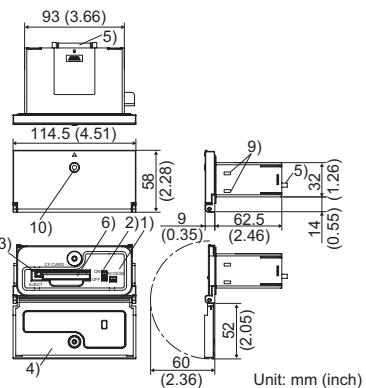

Unit: mm (inch)

No.	Name	Description
1)	CF card access LED	LED lamp lit when the CF card is accessed
2)	CF card access switch	Switch for disabling the access to the CF card ON: Access to the CF card enabled OFF: Access to the CF card disabled
3)	Eject button	Button for removing the CF card
4)	CF card cover	Cover opening/closing at CF card installation/removal
5)	Cable connector	Cable connector for connecting the GOT side installation unit and the control panel side installation unit
6)	CF card connector	Connector for installing the CF card
7)	Rating plate	-
8)	Fixing screw for GOT side installation unit	Fixing screw fixed with a front extension unit or the GOT
9)	Hole for unit installation fitting	Hole for the fitting installing the unit to the control panel
10)	Dustproof rubber	Rubber for blocking the CF card cover fixing screw hole

4. INSTALLATION PROCEDURE

The installation procedure for the CF card extension unit is explained using the GT1575.

4.1 Installing on GOT

- Power off the GOT.
- Remove one of extension unit cover of the GOT and fit the GOT side installation unit in the GOT case.
- Fix the GOT side installation unit by tightening its fixing screws (2 places) with a tightening torque of 0.36 to 0.48N·m.

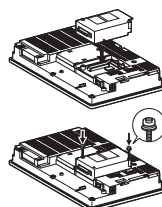

4.2 Installing on the control panel

- Insert the control panel side installation unit into the installation hole of the control panel. For the installation hole, refer to the figure right.
- Fix the GOT side installation unit by tightening its fixing screws (2 places) with a tightening torque of 0.36 to 0.48N·m.

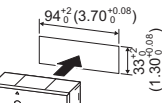

- Insert the connector with the ground cable into the GOT side installation unit, and insert the connector without the ground cable into the control panel side installation unit. (For GT1655 and GT155□, before connecting the connection cable to the GOT side installation unit, connect the ground cable of the connection cable to the GOT's terminal block. Because the GOT's terminal block overlaps with the connection cable, the ground cable cannot be connected to the GOT's terminal block.) After inserting the connectors, tighten the connection cable fixing screws.

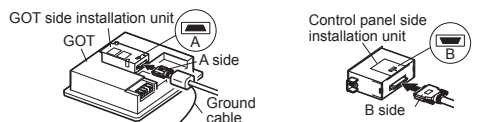

- Install the shorting bar to the LG and FG terminals of the GOT's power. Connect the ground cable of the connection cable with the GOT's ground cable to the FG terminal of the GOT's power. For GT1655 and GT155□, connect the ground cable of the connection cable to the FG terminal of the GOT's power, and connect the GOT's ground cable to the protective ground terminal. (Shorting is not needed.) When connecting the ground cables, each flat side of the two solderless terminals must be faced. For the details of wiring, refer to the User's Manual for the GOT used.

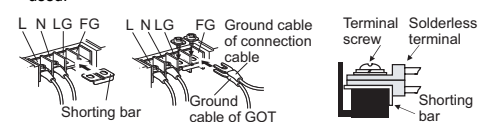

For the ground cable of the connection cable, use the following solderless terminals.

Applicable solderless terminal [RAV1.25-3, V1.25-B3A, FV1.25-B3A]

4.3 Installing CF Card Cover Fixing Screw

The protective structure of the outside of the enclosure for the control panel side installation unit is IP65 in shipping. For IP67 of the protective structure, follow the procedure below.

- Open the CF card cover, and remove the dustproof rubber in the direction of the arrow.
- Insert the CF card cover fixing screw into the hole of the CF card cover, and install the washer in the direction of the arrows.
- Close the CF card cover, and tighten the CF card cover fixing screw with a tightening torque of 0.11 to 0.48N·m.

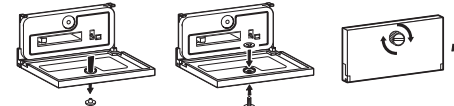

4.4 Installation and Removal Precautions

- When installing the CF card extension unit, make space of the dimensions shown in the following figures inside the control panel. The bending radius of the cable must be the value shown in the following figures.

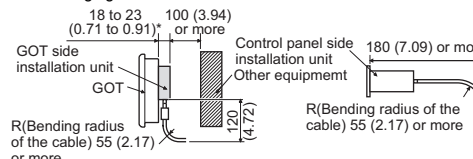

- *The dimension differs depending on the GOT. When installing the control panel side installation unit on the control panel, install the unit out of the way for the equipment inside the control panel, including the cables of extension units and the CF card interface of the GOT. Keep the distance of 25mm (0.98 inch) or more between the control panel side installation unit and the GOT. For the installation location, refer to the User's Manual for the GOT used.
- Extension units cannot be installed on the GOT side installation unit. When installing other extension units, install the GOT side installation unit at the last.
- When removing the GOT side installation unit, tilt ΔPULL of the unit and remove the unit so as not to break the connector.

5. CF CARD INSTALLATION/REMOVAL PROCEDURE

5.1 Installation

- Open the CF card cover and turn off the CF card access switch of the unit.
- Insert the CF card into the CF card connector with the front side facing up.



- Turn on the CF card access switch.

5.2 Removal

- Open the CF card cover. Turn off the CF card access switch and check that the CF card access LED turns off. (The CF card can be removed when the CF card access LED turns off even though the GOT's power is on.)
- When pressing the CF card eject button, the button pops out.

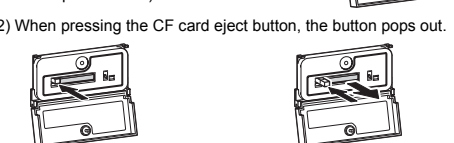

MITSUBISHI ELECTRIC CORPORATION

HEAD OFFICE: TOKYO BUILDING, 2-7-3 MARUNOUCHI, CHIYODA-KU, TOKYO 100-8310, JAPAN
NAGOYA WORKS: 1-14, YADA-MINAMI 5-CHOME, HIGASHI-KU, NAGOYA, JAPAN

When exported from Japan, this manual does not require application to the Ministry of Economy, Trade and Industry for service transaction permission.

Specifications subject to change without notice.
Printed in Japan, June 2011.